

Dual tank whole house filtration system

Ion Exchange technology (salt base)

Hardness, chlorine/chloramine

Why are people filtering out *hardness* and *chlorine* from their water?



Water is hard when it contains minerals like magnesium and calcium. You may see staining on your sinks, tubs, showers, and clothing. You may also notice less lather from your shampoos and soaps and even a feeling of film on your skin. Hard water causes a higher risk of lime scale deposits in household water systems. Due to this lime scale build-up, pipes are blocked and the efficiency of hot boilers and tanks is reduced. Water is softened or conditioned by replacing hard ions like magnesium and calcium with softer sodium or potassium ions. On-Demand initiated softeners regenerate automatically using on board computer, and only when it sense softening capacity is low.

All components are the highest quality in the industry and NSF approved. Du to patented Vortech Technology system performance is greater than any other water softener on the market today.

Benefits of soft water:

- Keeps skin and hair healthy looking
- Dishes are cleaner, with less soap and hard water spotting
- Tubs, showers, and sinks are easier to clean, thanks to reduced hard water build-up
- Clothes are softer, cleaner, brighter, and last longer
- Keeps all fixtures from scaling and corrosion
- Saves time, money and energy
- Towels washed in water softened by Eco Water Technology softeners need **50% less Detergent** and come out 45% whiter.

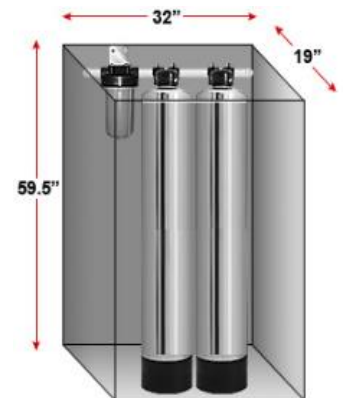

Benefits of chlorine free water:

Chlorine is a known poison and the safety of drinking this poison over a long term period is highly responsible for cancer. When you shower or bathe in chlorinated water, the pores of your skin open up and absorb the chlorinated water like a sponge. Also, Chlorine-filled Steam enters your lungs. People can actually receive more exposure to chlorine during a shower than by drinking the same water. Chlorinated Shower Water also causes or worsens skin irritations and rashes, dries the skin, can irritate eyes leaving them red, itchy and burning, and inhaling the steam can aggravate the sinuses and lungs as well.

Whole House Multi Stage, Double tank Water Filtration System it warranted for 5 years on electronic automatic valves, 5 years on system performance, and 10 years on media tanks.

Manufactured and assembled in USA since 1991

Phone: (949) 485-8652

